

# Series 822/823 Cassegrain Antennas

## Features

- ▶ Rugged Construction
- ▶ Low Loss Performance at Millimeter Wave Frequencies
- ▶ Minimal Spillover for Low Noise Performance

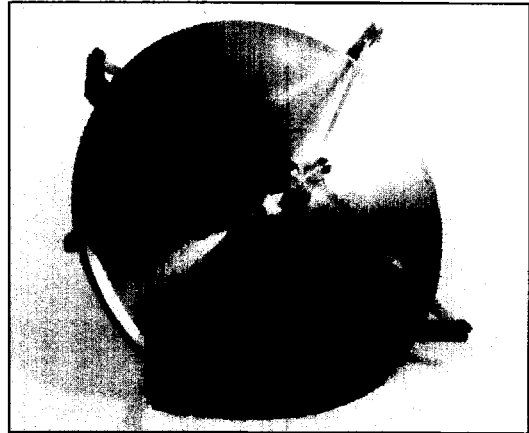

## Description

Each Cassegrain antenna consists of a parabolic reflector, a linearly-polarized primary feed, subreflector, and a feed support assembly of four low-profile aluminum spars that are attached to the rim of the reflector to position the feed accurately. This spar support presents negligible interaction with the radiated beam.

The Series 822 antennas feature a precision-machined aluminum casting as a main reflector which provides excellent performance at millimeter wave frequencies between 26.5 GHz and 220 GHz. This rugged design is recommended for frequencies where a low surface tolerance (typically 0.001 inch RMS) yields excellent high frequency radiation characteristics.

The Series 823 antennas feature metallized plastic reflectors and are available from 18.0 GHz through 100 GHz. They offer very high performance in a lightweight antenna structure. These antennas are available in effective diameters of 18 to 120 inches. Because of the low surface tolerance (typically 0.0025 inch RMS) they provide excellent high frequency radiation characteristics.

Alpha can also supply a lightweight version of the Series 822 and 823 antennas. With precision-machined aluminum main reflectors, the Series 824 antennas are

available with diameters from 12 to 24 inches. The Series 825 lightweight antennas have precision graphite main reflectors with diameters from 12 to 72 inches.

The Series 822/823 Cassegrain antennas are recommended for use at frequencies where the feed waveguide attenuation is appreciable and where the reflector is large enough to produce a beamwidth of one degree or less. At millimeter wavelengths, the loss in a waveguide from the input flange to the focus of parabolic reflector can be several dB. This results in a gain loss of the same magnitude. The series 822 and 823 Cassegrain antennas eliminate most of this loss since the feed horn is located close to the vertex of the main reflector. By eliminating the "long run" of waveguide, the associated loss is eliminated as well.

Band Letter	Series	Diameter
V through W	822,824	12
B through W	822,824	18
A through W	822,824	24
B through W	823,825	18
A through W	823,825	24
K through W	823,825	36
Ku through W	823,825	48

### Ordering Information

The center frequency should be specified when ordering these antennas. Each antenna is tested at the customer's center frequency up to 100 GHz and optimum focal adjustments are made. Test data will include principal E and H plane radiation patterns at the designated frequency.

For example: Model number 823024A-250/599 is a Series 823 antenna with a 24 inch effective aperture operating in A-band at 35 GHz with linear polarization and a 599 type flange at the output.

The same antenna with circular mode components becomes model number 823024A-250/C.

Please be sure to specify center frequency. The Series 822/823 Cassegrain antennas are linearly polarized, al-

though either dual or circular polarization can be achieved using the circular mode components described later in this section. Bandwidths are typically  $\pm 5\%$ . Sidelobes are nominally  $-18$  dB. Boresight telescopes and boresighting are recommended and are available on request. Special tests arrangements may be made for applications above 100 GHz depending on the availability of test sources.

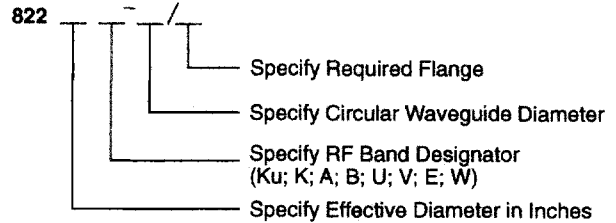

### Outline Drawing

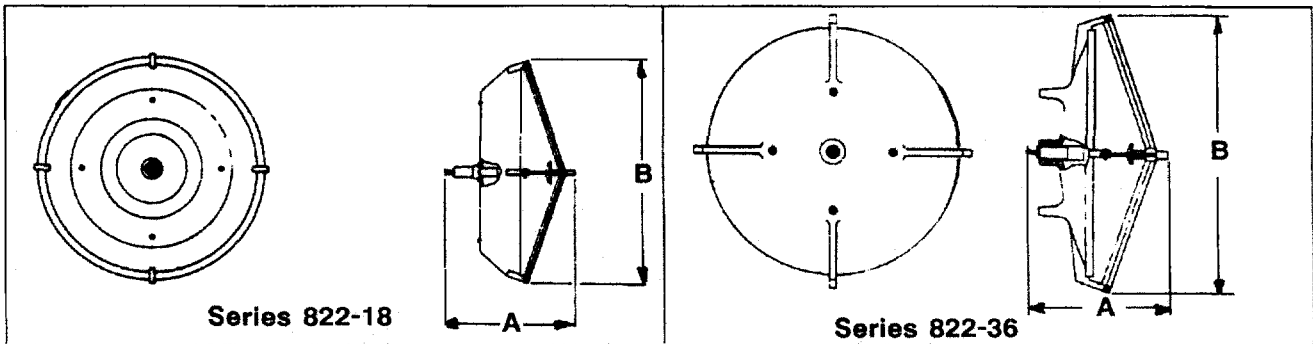

Effective Diameter (inches)	Series 822				Series 823			
	in	A mm	in	B mm	in	A mm	in	B mm
12	1.48	376	10.1	257	--	--	--	--
18	22.2	564	13.4	338	22.2	564	13.3	338
24	28.2	716	15.5	394	28.2	716	15.5	394
36	--	--	--	--	39.1	993	20.9	531
48	--	--	--	--	54.0	1372	23.0	594

### Typical Antenna Patterns for 822 Series Antenna

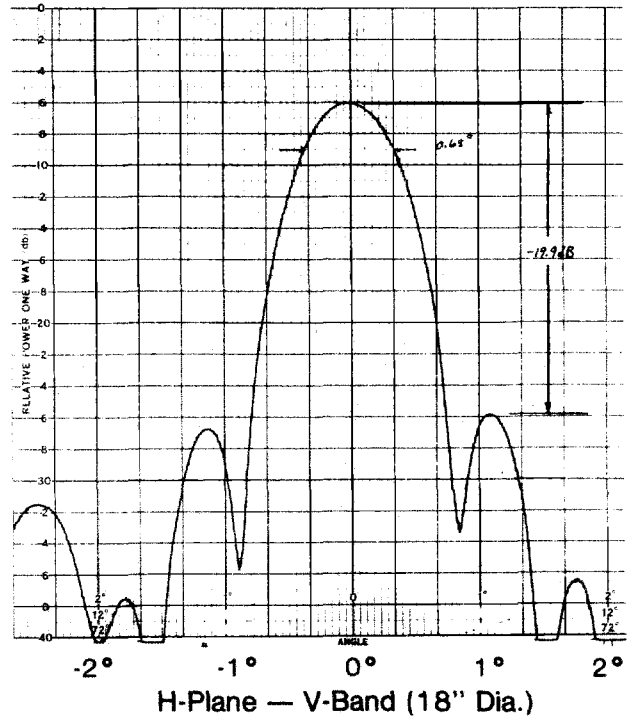
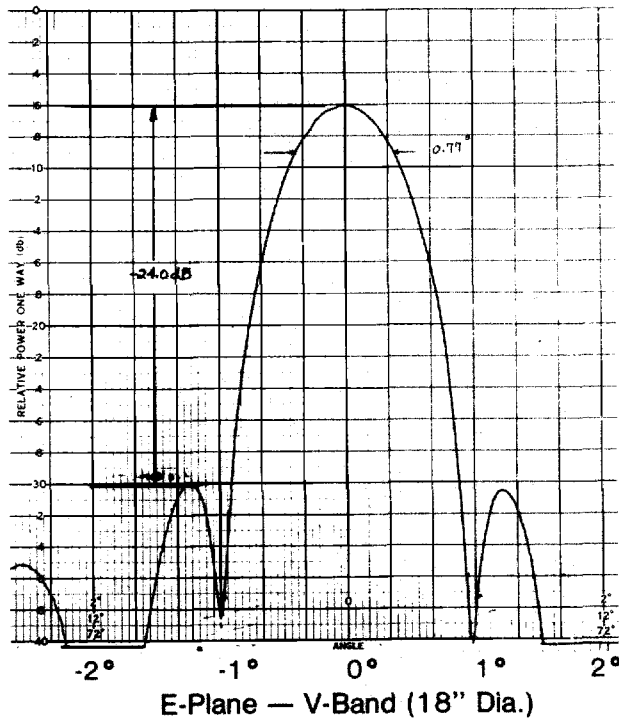
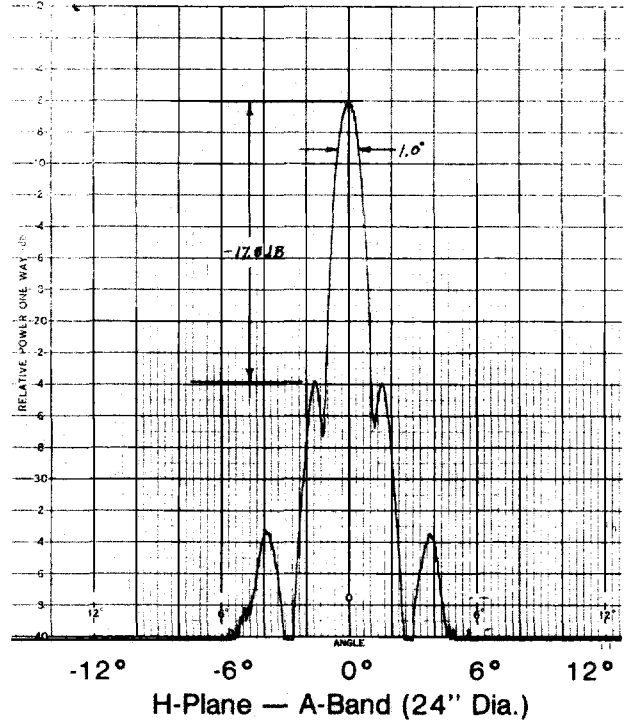
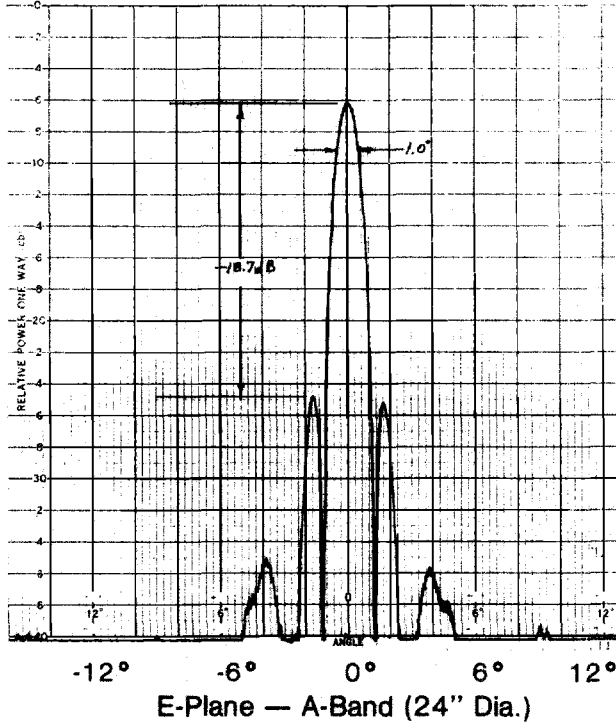

### Typical Antenna Patterns for 822 Series Antenna

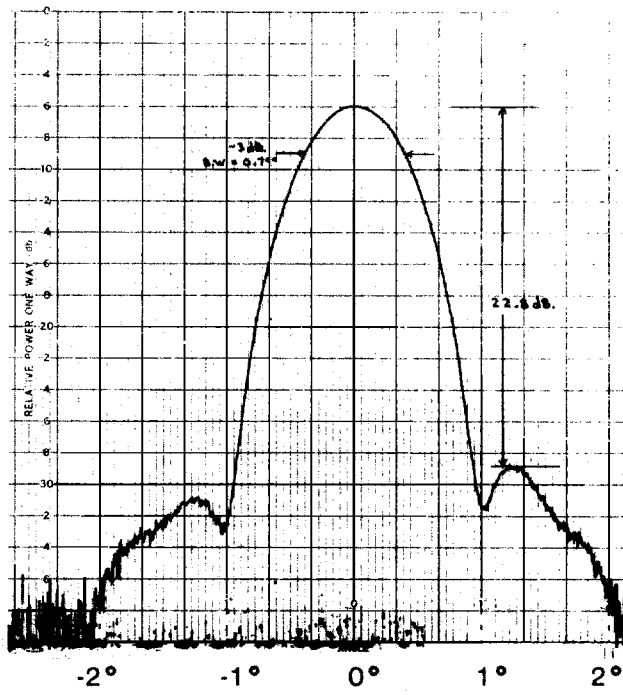

E-Plane — W-Band (12" Dia.)

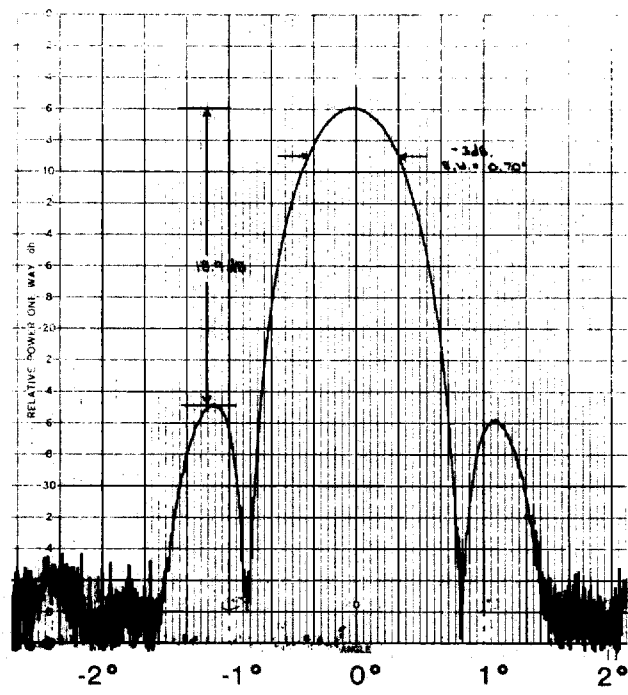

H-Plane — W-Band (12" Dia.)

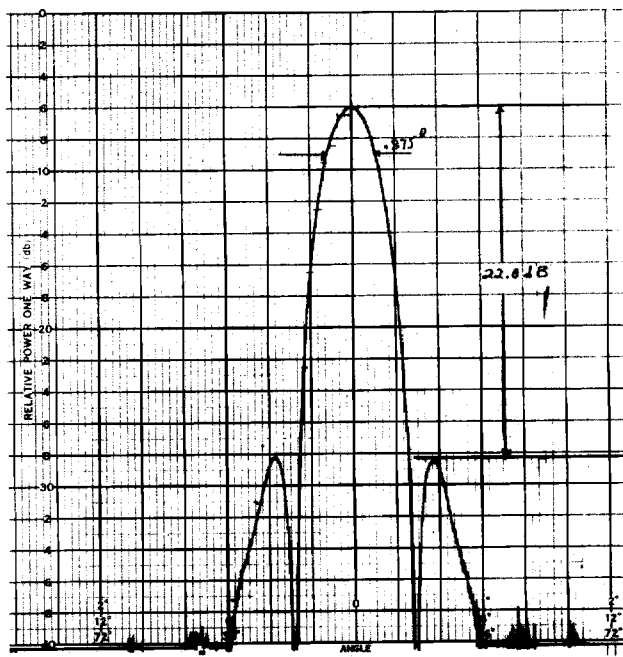

E-Plane — W-Band (24" Dia.)

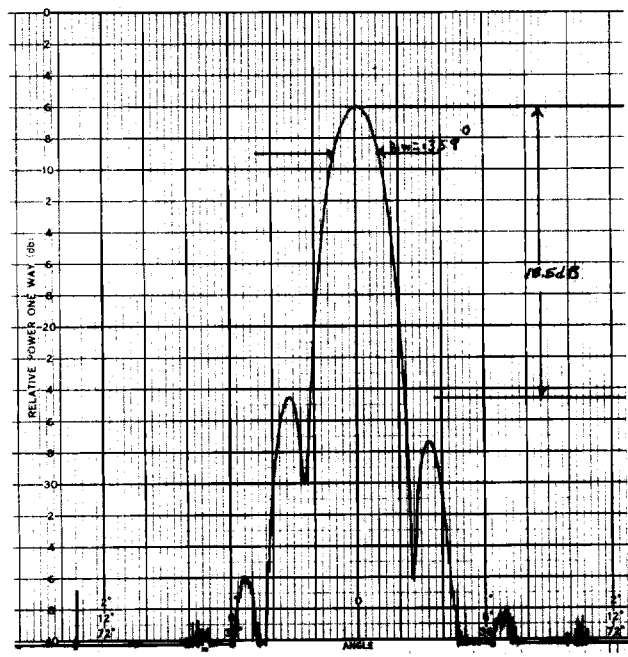

H-Plane — W-Band (24" Dia.)

### Typical Antenna Patterns for 823 Series Antenna

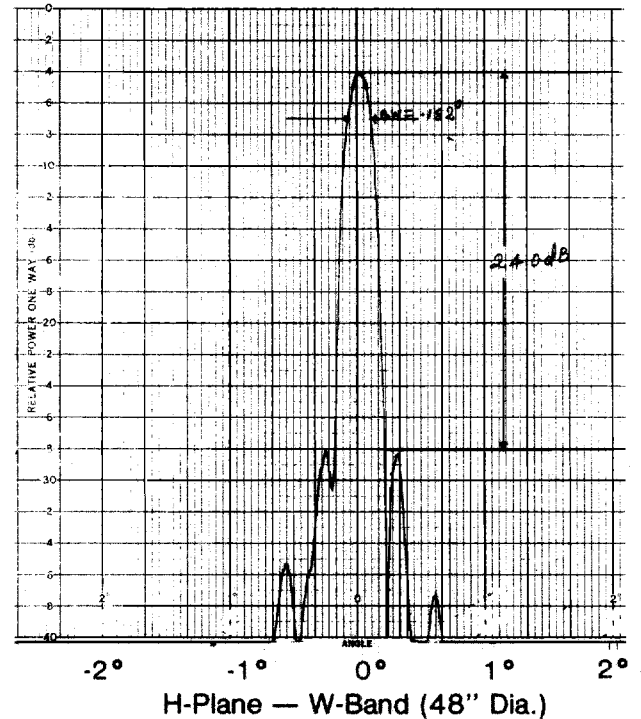
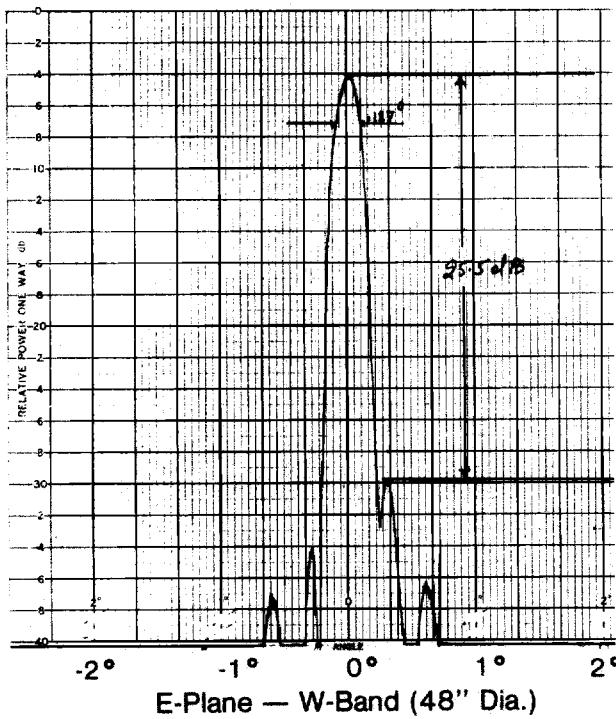
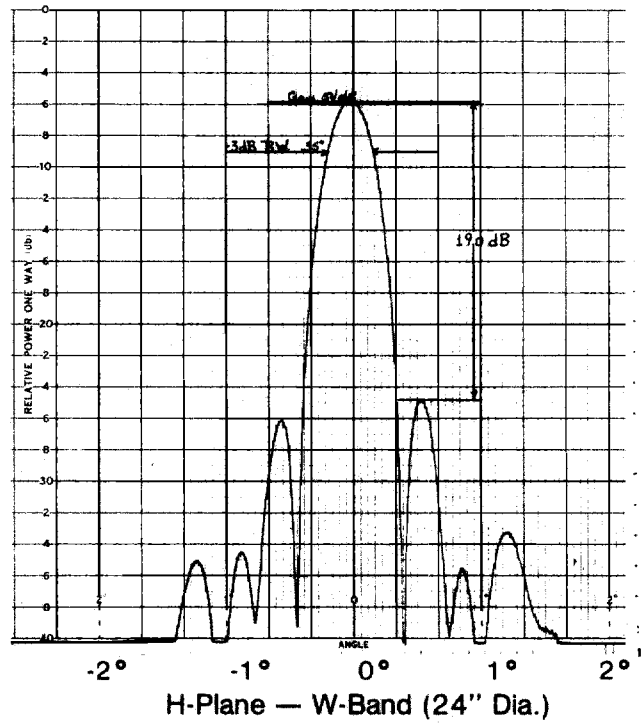
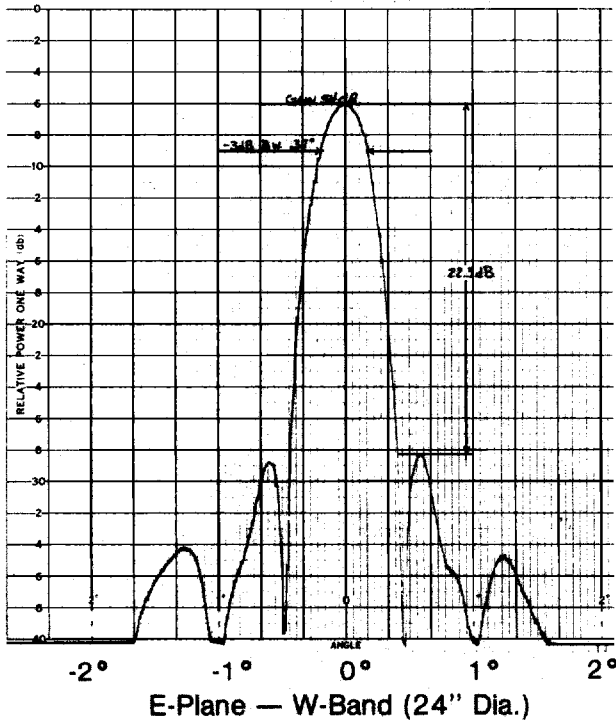

### Typical Antenna Patterns for 823 Series Antenna

